



MICRO-FLOW LEAK TESTING

Leading air leak testing solutions for your leak test challenges



LEAK TEST INSTRUMENTS

Proven and innovative technology

With the innovative Micro-Flow technology our leak testers are unique in the industry. The patented Micro-Flow sensors provide leak testing with short cycle times and leading temperature stability. Furthermore our leak testers provide superior sensitivity, robustness and repeatability compared to other air leak testing methods. Our technologies and products are recognized by multiple international Standards as SAE, USP, ASTM.

In addition to our Micro-Flow instruments, further connected solutions and services are provided through our global network.

Leak test instruments

- Pressure and flow test instruments
- Mass Extraction (vacuum) test instruments
- Calibrated leaks
- Flow standards/calibrators

Engineering and manufacturing

- Bench-top turnkey test solutions
- Engineering support for customized solutions

Services

- Product support: installation, annual calibration and repair
- Process integration and certification support (e.g. USP <1207>, GMP)
- ISO 17025 accredited calibration services – test services that include the use of hazardous gases.

ATC by Pfeiffer Vacuum

The Micro-Flow technology was developed by ATC (Advanced Test Concepts) which is based in Indianapolis (USA). ATC thereby has more than 30 years of experience with leak testing solutions for various Industries as Automotive, Pharma and Electronics. In 2017, ATC became a part of the Pfeiffer Vacuum family.

- ATC was established in 1987
- Started as a custom machine builder, recognized the need for a better leak testing method
- Developed the patented Micro-Flow sensor technology
- ATC's technology is installed in facilities all around the world
- ISO 17025:2005 calibration laboratory (accredited by A2LA)



Applications

Our Micro-Flow leak testers directly measure leak flow, making them versatile solutions that can be applicable to various industries. We thereby can support all of your applications whether you manufacture industrial items, automotive parts, or pharmaceutical products. We've helped to increase sensitivity and resolution accuracy and provide direct measurement with robust, operator independent test solutions. The following information will provide you with further specifications on our products. Please contact our application engineers with more specific details in order to analyze your application needs.

Industry applications examples

Automotive

- Powertrain – transmission and engine
- Fuel and brake systems
- Batteries
- HVAC

Pharmaceutical container closure integrity system

- Parenteral vials and pre-filled syringes
- Filled IV bags and blood bags
- Single use processing bags
- Autoinjectors

Medical device leak testing

- Drug delivery devices
- Catheters
- Implanted devices
- Pouches

Electronics and consumer electronics

- Leak testing to prevent water ingress (IP67 or similar rating)
- Semiconductor components
- Displays, computers and hard drives
- MEMS

Further applications

- Aerospace
 - HVAC components
 - Oil and gas industry
- and many more

Applications



Pharmaceutical packagings



Powertrain or automotive components



Electronics (IP class testing)

LEAK TEST INSTRUMENTS

Micro-Flow technology (pressure)

Micro-Flow technology

The heart of the Micro-Flow technology are our Intelligent Gas Leak Sensors (IGLS). The sensors measure flow, pressure and temperature to provide an output that is directly proportional to the leak rate respectively defect size.

In pressure regimes above atmospheric conditions, the Micro-Flow sensor is used as described in the pictures on the right hand side. When air leaks from the unit or assembly under test, the emitted air is replenished through the Micro-Flow sensor to maintain a constant pressure. The loss causes an electrical signal proportional to the volume flow. The Micro-Flow sensor thereby operates with a pressure reservoir, which is used to replenish the unit under test (UUT).

The sensor has a sensitivity of down to $5 \cdot 10^{-4}$ mbar l/s. Usually, only simple fixtures are necessary for this type of testing method.

Micro-Flow product overview



E-PDQ (EQ)



E2



IPE2



IPE2

Applications



Automotive industry



Medical devices



HVAC products

Air leak testing with Micro-Flow sensor at pressure conditions

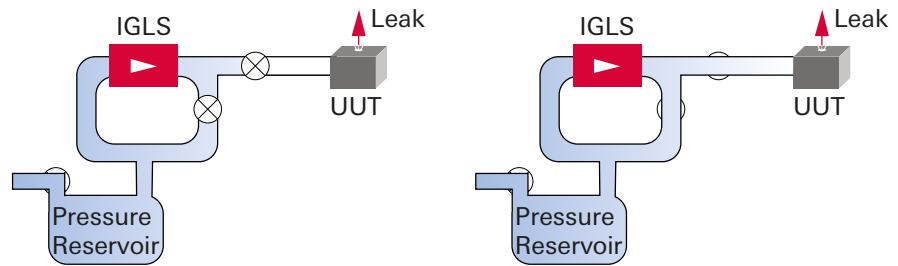

1 Standby – Pressure Reservoir: P_0
– IGLS: no flow

2 Fill – All branches: P_0
– IGLS: no flow
– UUT: leaks

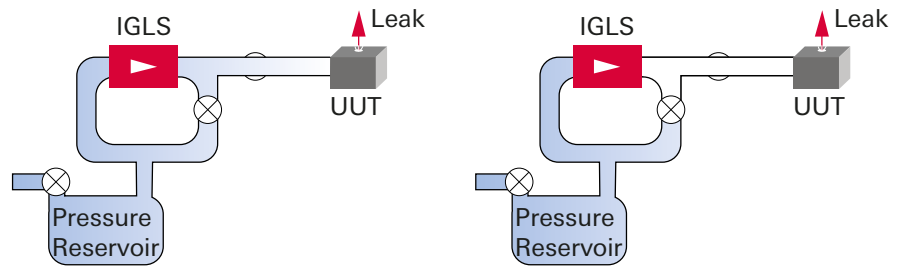

3 Stabilize – Leak: reduces P_{UUT}
– IGLS: begins flow

4 Test – Steady flow thru leak
– IGLS: measure flow

Basic structure of Micro-Flow set up (example with E2)

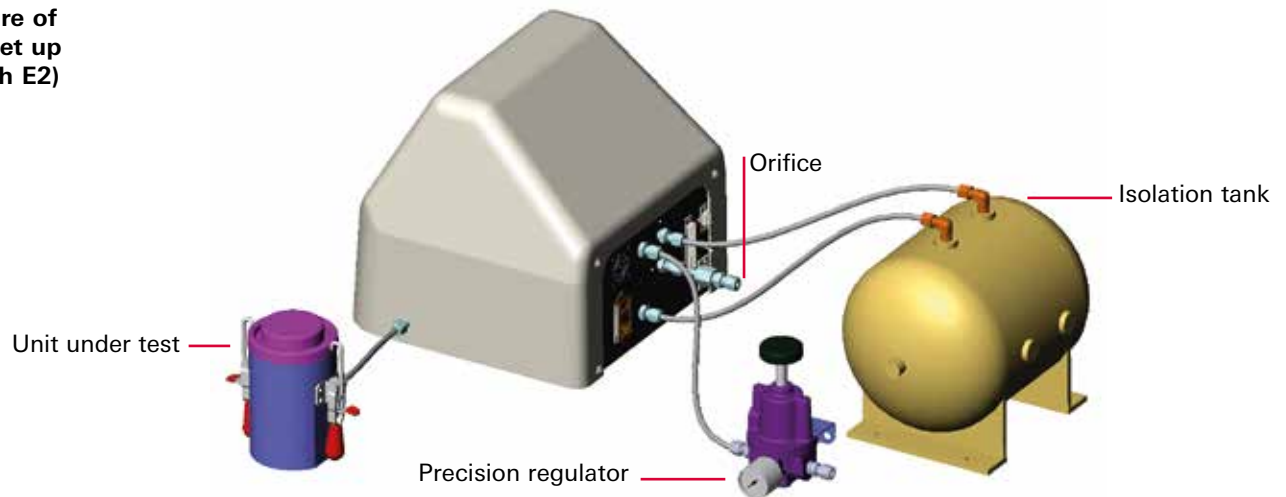

Customer benefits

- Speed of test – much faster than alternatives, e.g. 25-40% faster compared to pressure decay
- Higher sensitivity than traditional air testing technologies – down to $5 \cdot 10^{-4}$ mbar l/s respectively $3 \cdot 10^{-3}$ ccm
- Minimally affected by environmental changes – greatly reduces false results from environmental changes
- High accuracy – allows for setting thresholds for higher yield without risk of passing a bad part
- Repeatability – reduces false failures, a very costly issue
- Not sensitive to part size – one setup for multiple sized parts, reducing risk and time
- No daily calibrations required – stable test conditions with traceable test leaks
- Direct leak flow measurement – Micro-Flow leak measurement systems make a true measurement of the leak
- Simple to use – industrial rugged design

LEAK TEST INSTRUMENTS

Mass Extraction technology (vacuum)

Mass Extraction technology A special form of using the Micro-Flow sensor technology is the Mass Extraction technique. The basic principle is similar to the Micro-Flow approach, but in order to achieve higher sensitivity, the test is performed under vacuum conditions. This method incorporates sensor designs that operate at continuum/slip flow condition (shallow vacuum) and transitional/molecular flow regimes (deeper vacuum). This technology can also be used for the leak testing of closed containers such as packages or electronic enclosures. The unit under test is placed into a vacuum chamber with pressure conditions of 1 mbar or less. After the chamber is evacuated, the remaining flow between the chamber and the vacuum reservoir is used to determine the leak rate of the tested part (pictures on the right hand site). With this method, a sensitivity of down to $7 \cdot 10^{-7}$ mbar l/s can be reached.

Mass Extraction is thereby recognized by USP <1207> (Pharma Guideline) and ASTM (ASTM: F3287 - 17 "Nondestructive detection of leaks in packages by Mass Extraction method")

Mass Extraction product overview



E-PDQ (MQ)



VE2



ME3



ME2

Applications



Pharmaceutical packaging



Electronics



Medical devices

Air leak testing with Mass Extraction at vacuum conditions

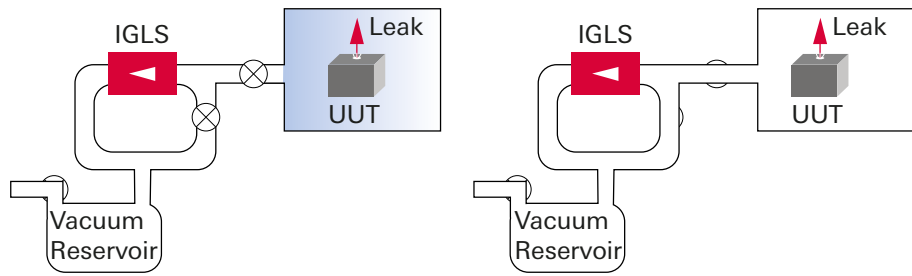

1 Standby – Vacuum Reservoir: P_0
– IGLS: no flow

2 Fill – All branches: P_0
– IGLS: no flow
– UUT: leaks

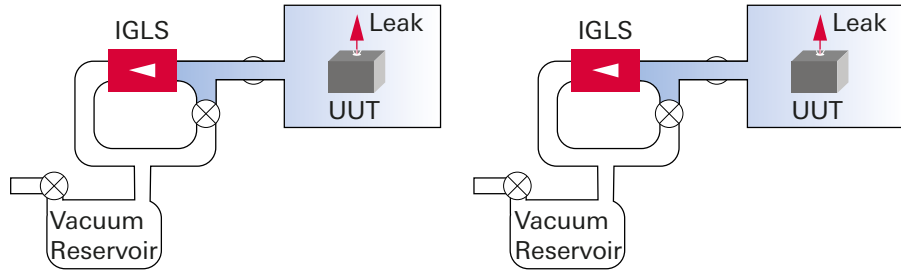

3 Stabilize – Leak: increases P_{chamber}
– IGLS: begins flow

4 Test – Steady flow thru leak
– IGLS: measure flow thru leak

Basic structure of mass extraction set up (example with VE2)

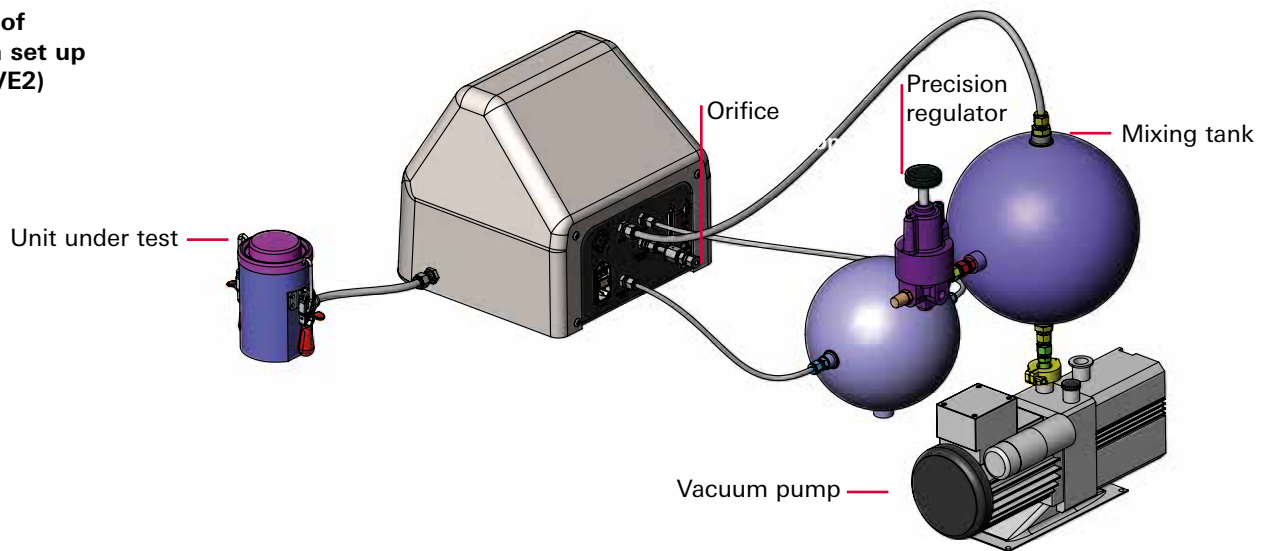

Customer benefits

- Especially suitable for sealed products/containers (e.g. CCIT¹)
- Nondestructive testing without use of tracer gas
- Very high sensitivity – detecting leak rates of down to $7 \cdot 10^{-7}$ mbar l/s ($<1 \mu\text{m}$)
- Separate gross leak test for larger defect – fast and reliable detection of gross leaks
- Minimally effected by environmental changes – greatly reduces false results from environmental changes
- High accuracy – allows for setting thresholds for higher yield without risk of passing a bad part
- Repeatability – reduces false failures, a very costly issue
- Not sensitive to part size – one setup for multiple sized parts, reducing risk and time
- No daily calibrations required – stable test conditions with traceable test leaks
- Recognized in industry standards as pharma USP <1207> – easy process validation
- ASTM recognized (F3287-17)

¹Container Closure Integrity Testing

LEAK TEST INSTRUMENTS

Sensors

Micro-Flow sensors

Our Micro-Flow leak testers are providing a unique and superior sensor technology. In comparison to other flow meters, our sensors do not work on the principle of temperature transfer or mechanical movements. Instead the sensors measure flow, pressure and temperature to provide an output that is directly proportional to the leak rate respectively defect size. This ensures a much more stable and robust measurement of the flow rate, which is also much less sensitive to environmental influences like temperature changes.

The sensors of our instruments are thereby selected to fit your dedicated application mainly depending on the pressure range you like to work in and the flow rate you need to detect. The broad range of sensor types and sizes thereby allows our previously sensitivity and accuracy in the field of air leak testing.

General information

General sensor specification for our IGLS and IMFS sensors

- Temperature range for operation: 0 to 50 °C
- Temperature range for storage: -25 to 50 °C
- Use parenthesis for gases
(air, nitrogen, helium, argon and carbon dioxide)
(Please consult us for the use of other gases)

Sensor specifications



Sensor model	IL2-C	IL2-L	IL2-M
Sensor type		Intelligent Gas Leak Sensor (IGLS)	
Minimum flow range	0–1 cc/min	0-1 l/min	0–0.025 cc/min
Maximum flow range	0–500 cc/min	0-25 l/min	0–5 cc/min
Pressure range	2–500 psia / \approx 0.15–34.5 bar abs	Barometric-100 psia / 7 bar abs.	2–65 psia / 0.15–4.5 bar abs.
Type	Absolute, micro-machined	Absolute, micro-machined	Absolute, micro-machined
Measurement uncertainty flow	+/- 1% (0.6% optional) of reading, calibrated range	+/- 1% (0.6% optional) of reading, calibrated range	+/- 2% (1% optional) of reading, calibrated range

¹⁾ 1 μ g/min=1.3 · 10⁻⁵ mbar l/s at STP

Sensor design

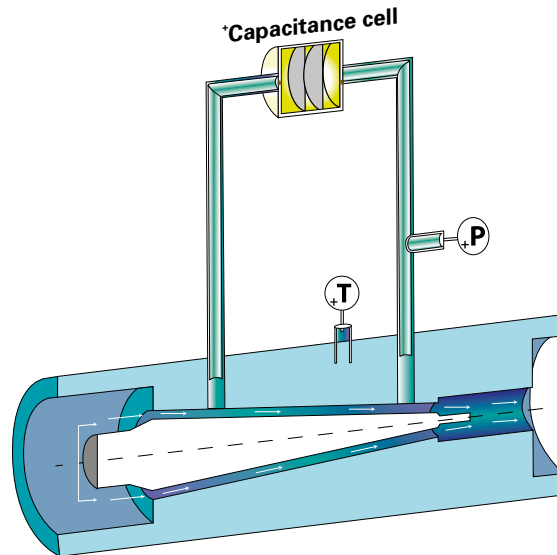

Pressure leak test instruments and Micro-Flow sensors

Instrument	IL2-C	IL2-L	IL2-M	IL2-KM	IL2-HP	IF2-HF	LCD Touch-screen	Ethernet
E-PDQ (EQ)			■	■			*	■
E2	■		■	■			■	■
IPE2	■	■	■	■		■	■	■
IPE2-HP					■		■	■

Vacuum leak test instruments and Micro Extraction sensors

Instrument	IL2-C	IL2-L	IL2-M	IL2-KM	IMFS	LCD Touchscreen	Ethernet
E-PDQ (MQ)			■	■		*	■
VE2	■	■	■	■		■	■
ME3		■	■	■	■		■
ME2	■	■	■	■	■	■	■
ME2-Packaging		■	■	■	■	■	■
IPE2	■	■	■	■		■	■

*The Model E-PDQ has a remote display option.

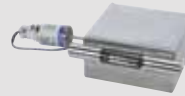

IL2-KM	IL2-HP	IMFS	IF2-HF
	Intelligent Molecular Flow Sensor (IMFS)		Intelligent Gas Flow Sensor (IGFS)
0–10 cc/min	0–1 cc/min	0–1 µg/min ¹⁾	0–50 l/min
0–250 cc/min	0–25 cc/min	0–400 µg/min ¹⁾	0–10,000 l/min
2–65 psia / 0.15–4.5 bar abs.	Barometric–2100 psia / 145 bar abs.	0–0.2 psia / 0–13 mbar abs.	Barometric–100 psia / 7 bar abs.
Absolute, micro-machined	Absolute, capacitance	Absolute, capacitance	Absolute, micro-machined
+/- 2% (1% optional) of reading, calibrated range	+/- 2% of reading, calibrated range	+/- 5% (2% optional) of reading, calibrated range	+/- 1% (0.6% optional) of volumetric flow, calibrated range

LEAK TEST INSTRUMENTS – E-PDQ

Compact design for Micro-Flow or Mass Extraction

E-PDQ is designed for quick production leak testing of small components, ensuring that products meet their leak tightness requirements. The compact design is perfect for system integration. It is available as EQ for pressure applications and MQ for vacuum applications.

Customer benefits

- Compact design – easy integration
- Integrated pressure (respectively vacuum) reservoir – simple test setup
- Cost efficient – fast return on investment

Solution example



Multi-Stations Leak and Flow Test System
for the Life Science Industry

Applications



Medical devices



Electronics



Valve



Technical data¹⁾

	EQ	E-PDQ	MQ
Applicable Micro-Flow sensors		IL2-M, IL2-KM	
Leak rates / sensitivity		0.03 cc/min and higher	
Pressure ranges	> 14.5 psia / 1 bar abs. to 65 psia / ≈ 4.5 bar abs.		2 psia / 0.138 bar abs. to 14.5 psia / 1 bar abs.
Dimensions		4" W x 6.25" H x 10" D / 102 x 159 x 254 mm (does not include connections and fittings)	
Gases		Dry, clean gases air, nitrogen (further gases detectable)	
Pneumatic connections		Test port 1/8 inch Swagelok®, air/vacuum supply 1/4 inch Swagelok®	
Digital inputs		5-30 VDC, Opto-Isolated for start, stop, test type, remote pressure switch	
Digital outputs		5-30 VDC, Opto-isolated for pass, fail, test type, test on, clamp, custom output	
Analog outputs		Single channel, 0-5 VDC pressure control	
Power supply		24 VDC (maximum current is 2 amp)	
Interfaces		RJ-45 Ethernet, or RS-232 Serial Interface	

¹⁾ Specific technical specification is dependent on the sensor used. We support you in selecting the perfect configuration for your application.

Product features

- Compact design provides small footprint
- Rack mounted design for testing multiple cavities simultaneously on same machine
- Version EQ offers Micro-Flow pressure testing
- Version MQ offers Mass Extraction testing under vacuum
- Remote Bluetooth graphical touchscreen display with LeakTek program and data storage²⁾
- Remote touchscreen display for rugged operation with no data storage
- Automated test circuit with valves and sequence controller
- Digital and analog I/O interface via Ethernet or serial port
- Easy to read LED to indicate test status: test, pass, or fail

²⁾ Compatible with Microsoft Windows® 10

LEAK TEST INSTRUMENTS – E2

Multipurpose pressure testing with Micro-Flow

Our popular efficiency instrument, model E2 is 25-40% faster compared to pressure decay. It is offered for industrial, rugged applications as well as aseptic and cleanroom applications (optional stainless steel housing). Its graphical display, real time signature graph and touch screen make it very user friendly without risking the integrity of test set up. It comes with the option to dynamically or statically assign an IP address, enabling remote interface through your LAN.

Customer benefits

- Automated pressure test circuit with balance and quick fill features – time saving
- User friendly operator interface for stand-alone applications – simple test setup
- Cost efficient – fast return on investment

Solution example



Dual station automotive coolant tank leak test machine

Applications

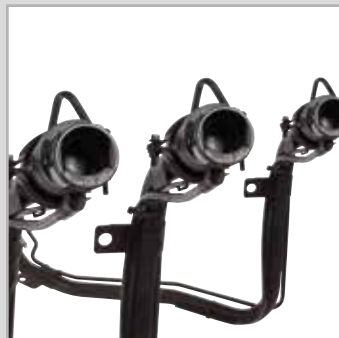

Automotive
(fuel parts)



Medical equipment
(drainage system)



Mechanical parts
(gear box housing)



Technical data¹⁾

E2	
Applicable Micro-Flow sensors	IL2-M, IL2-KM, IL2-C
Leak rates / sensitivity	0.1 cc/min and higher
Pressure ranges	14.5 psia to 165 psia / 1 bar – 11 bar (absolute)
Dimensions	12" W x 12" H x 12" D / 305 x 305 x 305 mm (does not include connectors and fittings) Expansion tank and pressure regulators are externally mounted
Gases	Dry, clean gases air, nitrogen (further gases detectable)
Pneumatic connections	¼ inch Swagelok®
Digital inputs	5 VDC, Opto-Isolated for start, stop, type, pressure switch, verify
Digital outputs	30 VDC-20 mA, Opto-isolated for pass, fail, clamp, test type, exhaust and custom
Analog outputs	single channel, 0-5 VDC pressure control
Power supply	115 VAC/60 Hz, 220 VAC/50 Hz (optional)
Interfaces	RJ-45 Ethernet, or RS-232 Serial Interface

¹⁾ specific technical specification is depending on used sensor, we are happy to support you to select the perfect configuration for your application

Product features

- Medium size parts, higher throughput
- User friendly operator interface for stand-alone applications
- Automated pressure test circuit with balance and quick fill features
- Front TFT graphical color display with touch screen
- Optional verification orifice (calibrated leak)
- Digital and analog I/O interface via Ethernet or serial port
- Stainless steel enclosure for cleanroom available
- Multiple test profiles
- UL and CE approved

LEAK TEST INSTRUMENTS – VE2

High sensitivity leak testing with air in vacuum

The Model VE2 is a popular Mass Extraction instrument with an additional built-in quick fill circuit for higher throughput, handling medium size parts with leak tightness from $1 \cdot 10^{-4}$ sccs with air. It is offered for industrial applications as well as aseptic and cleanroom applications (optional stainless steel housing). Its graphical display, real time signature graphs and touch screen make it very user friendly without risking the integrity of the test set up. It can be assigned an IP address enabling interface through your LAN.

Customer benefits

- Detection of leaks down to $1 \cdot 10^{-4}$ sccs with air – high sensitivity
- Automated vacuum test circuit with balance and quick evacuation features – time saving
- User friendly operator interface for stand-alone applications – simple test setup

Solution example



Pouch testing leak test set-up

Applications

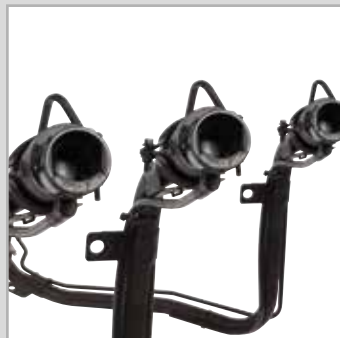

Fuel fillers



Pouches and trays



Valve



Technical data¹⁾

VE2	
Applicable Micro-Flow sensors	IL2-C, IL2-KM, IL2-M at pressures from atmosphere to 2 psia vacuum (≈ 138 mbar abs.)
Leak rates / sensitivity	$1 \cdot 10^{-4}$ sccs (≈ $1 \cdot 10^{-4}$ mbar l/s)
Pressure ranges	Vacuum - 2 psia (≈ 138 mbar abs.) to barometric pressure
Dimensions	12" W x 12" H x 12" D / 305 x 305 x 305 mm (does not include connectors and fittings) Expansion tank and vacuum regulators are externally mounted
Gases	Dry, clean gases air, nitrogen (further gases detectable)
Pneumatic connections	Test ports and vacuum 3/8 inch Swagelok® (on side of instrument)
Digital inputs	5 VDC, Opto-Isolated for start, stop, type, pressure switch, verify
Digital outputs	30 VDC-20 mA, Opto-isolated for pass, fail, clamp, test type, exhaust and custom
Analog outputs	single channel, 0-5 VDC pressure control
Power supply	115 VAC/60 Hz, 220 VAC/50 Hz (optional)
Interfaces	RJ-45 Ethernet, or RS-232 serial interface

¹⁾ specific technical specification is depending on used sensor, we are happy to support you to select the perfect configuration for your application

Product features

- Micro-Flow sensor—IGLS²⁾ (vacuum generation)
- Automated vacuum test circuit with balance and quick evacuation valves
- Front TFT graphical color display with touch screen
- Optional verification orifice (calibrated leak)
- Digital and analog I/O interface via Ethernet or serial port
- Stainless steel enclosure for aseptic and cleanroom applications
- Multiple test profiles

²⁾ Intelligent Gas Leak Sensor

LEAK TEST INSTRUMENTS – IPE2, IPE2-HP

High sensitive and fast air leak testing for demanding applications

The model IPE2 is our top of the line industry focused leak testing instrument. Designed for demanding applications from high pressure testing to dual channel capabilities where short cycle times are a must. This instrument is built for heavy usage and testing large size parts.

Customer benefits

- High pressure valves and fittings for demanding applications – robustness
- Dual channel option for faster through put – time saving
- Dual channel can combine vacuum and pressure testing – flexibility

Solution example



Dual station radiator leak test system

Applications



Radiators



Tubing



Automotive transmission housing



Technical data¹⁾

IPE2, IPE2-HP	
Applicable Micro-Flow sensors	IL2-C and IL2-L, IL2-M, IL2-KM, IL2-HP, IF2-HF (flow/constriction/blockage tests)
Leak rates / sensitivity	down to 0.02 cc/min
Pressure ranges	up to 2100 psia (≈ 145 bar abs.)
Dimensions	27" W x 24" H x 19" D / 686 x 610 x 483 mm (does not include connectors and fittings) Expansion tank and pressure regulators are externally mounted
Gases	Dry, clean gases air, nitrogen (further gases detectable)
Pneumatic connections	1/4 inch to 1/2 inch Swagelok® (application dependent)
Digital inputs	5 VDC, Opto-Isolated for start, stop, type, pressure switch, verify
Digital outputs	30 VDC-20 mA, Opto-isolated for pass, fail, clamp, test type, exhaust and custom
Analog outputs	single channel, 0-5 VDC pressure control
Power supply	115 VAC/60 Hz, 220 VAC/50 Hz (optional)
Interfaces	RJ-45 Ethernet, or RS-232 serial interface

¹⁾ specific technical specification is depending on used sensor, we are happy to support you to select the perfect configuration for your application

Product features

- 1-2 independent test channels – can combine pressure and vacuum test
- Single or dual test channels with pressure leak testing and/or constriction/blockage flow testing channel
- Test large volume and complex parts in short cycle time
- The high pressure (HP) options feature automatic high pressure test circuit for single channel
- Optional stainless steel, high pressure test circuit
- User friendly operator interface for stand-alone equipment
- Digital and analog I/O interface via Ethernet or serial port for each test channel
- Optional sort test controller

LEAK TEST INSTRUMENTS – ME2

High performance Mass Extraction (vacuum) leak testing

The model ME2 is a popular Mass Extraction test instrument using air for high sensitivity demanding applications. Designed for medium sized parts with higher throughput, this instrument is offered for cleanroom or industrial applications. The ME2 is particularly useful in high demanding pharmaceutical applications for CCIT (Container Closure Integrity Testing).

Customer benefits

- Detection of leaks down to 1 μm defect size and below with air – highest sensitivity
- With very simple chamber adaption set up can be used for various parts – flexible
- User friendly operator interface for stand-alone applications – simple test setup

Solution example



Mass Extraction test carts (for pharmaceutical laboratories)

Applications



Vials



IV bags



Batteries



Technical data¹⁾

	ME 2	
	Shallow vacuum	Hard vacuum sensor
Applicable Micro-Flow sensors	IL2-M, calibrated from 2 psia (≈ 138 mbar abs.) to barometric (slip and viscous flow regimes)	IMFS calibrated from 0.01 to 0.2 psia (≈ 1 to 14 mbar abs.) (molecular and transitional flow regimes)
Leak rates / sensitivity	$1 \cdot 10^{-4}$ sccs (≈ $1 \cdot 10^{-4}$ mbar l/s) at 2 psia (≈ 138 mbar abs.)	$7 \cdot 10^{-7}$ sccs (≈ $1 \cdot 10^{-7}$ mbar l/s / 0.2 μm defect size) at 0.02 psia (≈ 1 mbar abs.)
Pressure ranges	Vacuum – 0.01 psia (1 mbar abs.) to barometric pressure	
Dimensions		
– ME2 (Instrument)	27" W x 24" H x 19" D / 686 x 610 x 483 mm (does not include connectors and fittings)	
– Operational cart	28" W x 47" H x 20" D / 711 x 1194 x 508 mm Expansion tank, vacuum generation and control package are externally mounted on optional cart.	
Gases	Dry, clean gases air, nitrogen, water vapor (further gases detectable)	
Pneumatic connections		
– Air supply	1/4 inch Swagelok®	
– Vacuum	3/8 inch to 1 inch NW (application dependent)	
Digital inputs	5 VDC, Opto-isolated for start, stop, type, pressure switch, verify	
Digital outputs	30 VDC-20 mA, Opto-isolated for pass, fail, clamp, test type, exhaust and custom	
Analog outputs	single channel, 0-5 VDC pressure control	
Power supply	115 VAC/60 Hz, 220 VAC/50 Hz (optional)	
Interfaces	RJ-45 Ethernet, or RS-232 serial interface	

¹⁾ specific technical specification is depending on used sensor, we are happy to support you to select the perfect configuration for your application

Product features

- Mass Extraction tests under vacuum
- Medium size parts, higher throughput
- Automated vacuum test circuit, uniquely designed for ultra-tight leak specification
- Built in balance and quick evacuation circuits
- Front graphical display with touch screen
- Optional verification orifice (calibrated leak)
- Digital and analog I/O interface via Ethernet or serial port
- Stainless steel enclosure for clean room
- Various sizes of oil-less vacuum generation and control packages are available
- Optional test cart, one or more test chambers (toolings), quick tooling change over

LEAK TEST INSTRUMENTS – ME3

High performance Mass Extraction (vacuum) in-line leak testing

The model ME3 is an in-line high speed container closure integrity testing unit that utilizes ATC's Mass Extraction technology (vacuum). Built for high-speed production lines capable of detecting a fraction of a micron defect size, or high speed production up to 120 ppm with multiple stations. The ME3 is particularly used in high demanding pharmaceutical production environments for CCIT (Container Closure Integrity Testing).

Customer benefits

- Detection of leaks down to 1 μm defect size and below with air – highest sensitivity
- Compact design – easy integration
- Upstream large leak check for quick decision for larger defects – speed of test

Solution example



100% in-line IV bag Container Closure Integrity Testing

Applications



Vials



IV bags



Batteries



Technical data¹⁾

	ME3	
	Shallow Vacuum	Hard vacuum sensor
Applicable Micro-Flow sensors	IL2-M, calibrated from 2 psia (≈138 mbar) to barometric (slip and viscous flow regimes)	IMFS calibrated from 0.01 to 0.2 psia (≈ 1 to 14 mbar abs.) (molecular and transitional flow regimes)
Leak rates / sensitivity	$1 \cdot 10^{-4}$ sccs (≈ $1 \cdot 10^{-4}$ mbar l/s) at 2 psia (≈ 138 mbar abs.)	$7 \cdot 10^{-7}$ sccs (≈ $1 \cdot 10^{-7}$ mbar l/s / 0.2 μm defect size) at 0.02 psia (≈ 1 mbar abs.)
Pressure ranges	Vacuum – 0.01 psia (1 mbar abs.) to barometric pressure	
Dimensions	6 3/4" W x 11 1/8" H x 22 1/4" D / 172 x 283 x 565 mm (does not include connectors and fittings)	
Gases	Dry, clean gases air, nitrogen, water vapor (further gases detectable)	
Pneumatic connections	1/4 inch Swagelok® 3/8 inch to 1 inch NW (application dependent)	
Digital inputs	5 VDC, Opto-Isolated for start, stop, type, pressure switch, verify	
Digital outputs	30 VDC-20 mA, Opto-isolated for pass, fail, clamp, test type, exhaust and custom	
Analog outputs	single channel, 0-5 VDC pressure control	
Power supply	115 VAC/60 Hz, 220 VAC/50 Hz (optional)	
Interfaces	RJ-45 Ethernet, or RS-232 serial interface	

¹⁾ specific technical specification is depending on used sensor, we are happy to support you to select the perfect configuration for your application

Product features

- Micro-Flow sensor – IGLS (Intelligent Gas Leak Sensor) or IMFS (Intelligent Molecular Flow Sensor)
- Automated vacuum test circuit, uniquely designed for ultratight leak test
- High-speed evacuation circuit, for in-line process testing, where short test times are required
- Designed to be part of a rotary or linear continuous operation system
- Multiple instruments for high-speed production lines
- Large leak and fine leak tests
- Displays real time pressure, flow test messages
- Separate controller box can support up to 5 instruments
- Slave to a remote PLC/PC
- Ethernet interface to simplify integration
- Stainless steel enclosure for clean room

APPLICATIONS

Pharmaceutical packaging and electronics IP testing

Closure Integrity Testing for pharmaceutical containers and products

Increasing demands for Container Closure Integrity Testing (CCIT) in the pharmaceutical industry are driven by recent FDA guidelines for sterile barrier. Whether you are testing sterile barrier, moisture barrier or general protection packaging we offer nondestructive container closure integrity test equipment for:

- Off-line CCIT
- Automatic, high speed robotic sampling
- In-line 100% inspection

Replace destructive blue dye traditional testing with our patented and robust Mass Extraction technology, which offers a more cost effective replacement to test your products using air with measurements similar to helium mass spectrometry levels. Our USP <1207> recognized technology thereby provides user-independent and quantitative measurement of defect sizes down to 1 micron.

With this very versatile technology you can thereby measure all kinds of non-porous containers and can also test different sizes with the same settings only by the change of simple fixtures.

Pharmaceutical Container Closure Integrity system-testing

- Parenteral Vials and pre-filled syringes
- Cartridges and auto injection devices
- Flexible bags (IV bags, blood bags), empty and filled
- Single use flexible bag systems for pharmaceutical process-incoming inspection and point of use leak testing
- Pouches and inhalers and many more



Mass Extraction cart for pharmaceutical laboratories

Electronics and consumer electronics

ATC's leak testing instruments and machines test consumer electronic products with air to meet common standards such as IPX7 and IPX8. ATC will help you define your leak tightness requirements using air and instead of water for a faster, more sensitive and reliable test. Our Mass Extraction technology can also perform material testing (permeation) in seconds and minutes replacing days of testing with current technologies.

Our instruments and systems will provide you with a faster cycle time and unprecedented temperature stability with external and internal leak testing solutions that are repeatable and reliable. Consult us to define the maximum allowed pinhole (equivalent channel) for your leak testing requirement.

Water Ingress Protection (IP) of electronics and components

- (Consumer) Electronics with IPX7 or IPX8 rating
 - Lighting (including LED)
 - Cameras and optical components
 - Sensors, harness, connectors
 - Alternators and starters
 - Displays, computers and hard-drives
 - Electrical controls, batteries
- and many more



Ingress protection leak test system

APPLICATIONS

Automotive

Automotive leak testing

Leak testing requirements in the automotive industry are getting more and more challenging. On one hand the leak specifications are becoming tighter due to environmental guidelines and reliability demands, on the other hand the quality requirements from automotive OEMs are increasing.

Our Micro-Flow and Mass Extraction technologies can help you with this increasing requirements thanks to higher sensitivity and repeatability compared to other air leak testing technologies. Furthermore the faster cycle times can help you to increase your capacity without the need of additional test stations thanks to the higher throughput.

Automotive fuel and brake systems

Especially leak testing of automotive fuel and brake components/assemblies is challenging. Whether it is newer emission and safety specifications or tighter OEM specifications, ATC has extensive knowledge and experience in the automotive industry. We've helped to develop some of these specifications for fuel and vapor components. ATC brake system leak testing products exceed the requirements of common SAE (e.g. J2973) and OEM requirements, performed at high pressure. Our constriction tests comply to US-DOT requirements.

Our equivalent channels meet the requirements of US-CAR, SAE J2045, SAE J2587, SAE J2973 for US-CARB LEV II + PZEV, EURO-5 hydrocarbon emission standards and major OEM leak tightness specifications such as Ford ES YU5A-9000AC and US-CAR.



Fuel filler neck Micro-Flow test system

Fuel systems and components

- Fuel line assembly leak and blockage test
- Vapor line assemblies leak test
- Fuel flanges leak detection
- Canisters leak testing
- Connectors, valves, sensors, components leak and flow testing
- Filler tube assemblies, capless and components leak test
- Fuel rails (gasoline and diesel) leak testing
- Fuel tanks (small, metal)

For larger fuel tanks we also provide corresponding helium leak detection equipment, please consult us for further information

Brake systems and components

- Master cylinder leak and constriction test
- Slave cylinders leak testing
- Jounce lines leak and constriction testing
- Brake lines-rigid and flexible leak and constriction testing
- Sensors valves and components leak testing

Further critical automotive components

The leak testing applications within the automotive industry are very broad. The following list should give you an example of further applications in which our Micro-Flow and Mass Extraction technologies helped our customer to increase their process capability, reduce their cycle times and tightening their sensitivity levels.

We thereby work with our customers from helping you to define the maximum allowed defect size (diameter and length) using our proven correlation test methods and certified micro-geometries and support you until the implementation of the test process in your production.

Transmission

- Prismatic casting porosity: housing and covers as cast and machined leak and blockage testing
- Torque converter leak testing
- Clutches, valve bodies leak and flow testing
- Complete transmission assemblies leak testing

Engine

- Casting porosity: blocks, heads, and covers: casting and machined leak and blockage testing
- Engine subassembly: oil, water and fuel leak testing
- Components: pumps, thermostats, valves, sensors, control module leak test
- High pressure fuel pumps, fuel rails, diesel pumps and components leak testing
- Turbochargers leak and flow testing
- Injectors leak testing
- Crankshaft constriction (blockage) testing new part description complete engine assembly leak testing

Advance propulsion system (Electrical Vehicle (EV), natural gas, fuel cell systems and components)

- EV Batteries, cells and components leak test (water and moisture ingress) battery coolant circuits
- Natural gas systems and components leak test (regulators, valves, hose assemblies and components)
- Electric drives and controls leak testing
- Fuel cells leak test and flow applications

As well as

- Climate control and powertrain cooling
- Water ingress protection (IP) of electronics, lightning and optical systems and components
- Automotive hydraulics and many more

CALIBRATED LEAK DEVICES

Equivalent Channel (EC) and Equivalent Diameter (ED)

Calibrated leak devices

Leak rates can be defined in various ways and units. Whilst the helium leak detection world is mainly using mbar l/s to define leak rates, bigger leaks are often defined in cm^3/min or ml/min .

Another way to define the reject level for your unit under test is to define the maximum allowable defect size that can be tolerated in your test part. The idea behind this method is, that any defect which is smaller than the defined "maximum defect size" will be blocked by the media inside your part respectively will not allow critical media to get inside of your part. This approach is for example widely used in the pharmaceutical area, where reject levels are defined in relation to virus or bacteria sizes. Also in different USA automotive standards, the definition of maximum defect sizes became more and more popular in the last years. ATC played an important role in many of this processes. In our certified laboratories we helped to define maximum allowable defect sizes for various applications.

On the basis of this experience we developed our various calibrated leak devices to meet requirements of different industries which are used to:

- Set up leak testing equipment based on the leak rate to be detected
- Verify or validate a leak test system's capability to detect leaks
- Compare leak test methods and machines

Applications



ATC's equivalent channels utilize geometric approach

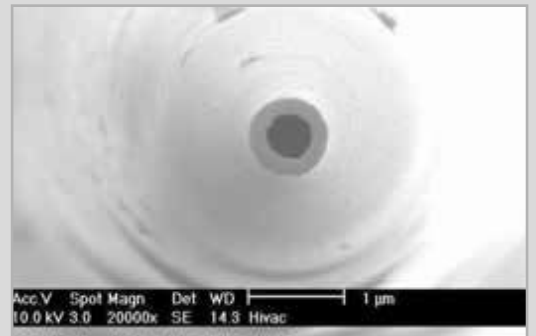

Glass orifice – scanning electron microscope tip image, diameter: 0.4 micrometer

**Equivalent Channel Standard (ECS)
Equivalent Channel Device (ECD)**

ECS (Equivalent Channel Standard) and Equivalent Channel Device (ECD) are both characterized by the fact that the ratio between length and diameter is large. ECS devices are thereby supplied with traceable gaging certificate of the inlet diameter, outlet diameter and minimum length. ECD devices on the other hand are certified for flow rate with air/ nitrogen or other gasses per customer request (standard 3 points, air/nitrogen, barometric outlet, others available).

Those Equivalent Channels meet the requirements of US-CAR, SAE J2045, SAE J2587 and SAE J2973 for US-CARB LEV II + PZEV and the EURO-5 hydrocarbon emission standards.

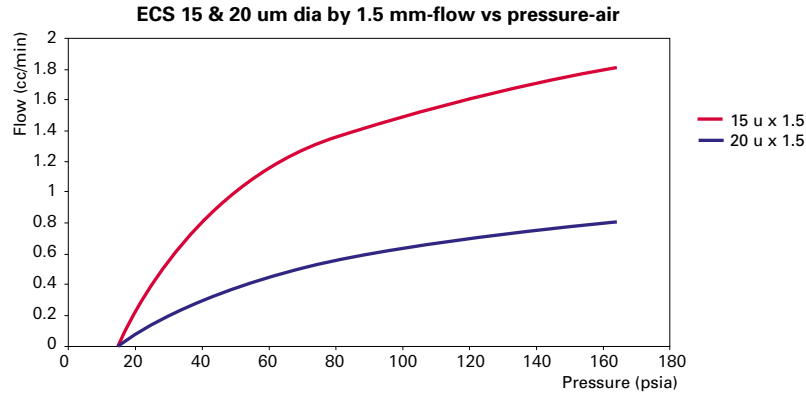

**Equivalent Diameter (ED)
and Sharp Edge orifice (SE)**

In comparison to the ECS and ECD devices Sharp Edge (SE) orifices, known also as Equivalent Diameters (ED) have a length to diameter ratio is small. ED and SE devices are built to size and flow calibrated at test pressure and gas type. As a geometric definition of leak tightness those devices are recognized by pharma regulation USP <1207>, as they offer the most generic and conservative way to simulate pinholes or leak paths.

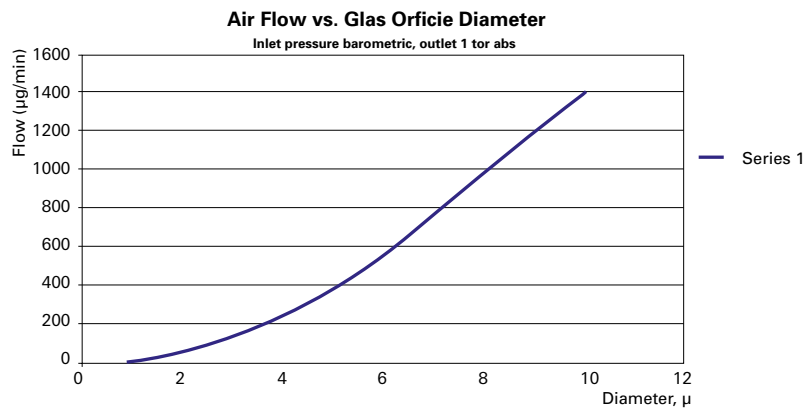
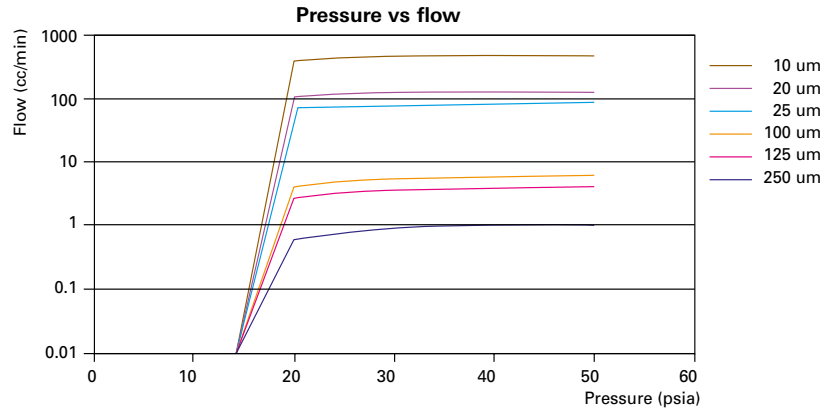

CALIBRATED LEAK DEVICES

ECS, ECD and ED configurations

Calibrated leak devices

Our calibrated leak devices come in a variety of configurations to meet your needs. Available body types are shown below. The standard Swagelok body is the default design unless otherwise specified. Each calibrated leak device is supplied with:

- A filter, as part of a leak test instrument
- A calibration certificate, NIST traceable
- 1/4" Swagelok female connection

The ECD/ECS are constructed from silica (glass) and encapsulated in stainless steel housing. Our unique manufacturing process ensures a uniform and smooth bore. SE/EDs have sapphire or glass orifices, which offer exceptional long term geometric consistency due to their hardness and excellent stability (low temperature expansion coefficients). The orifices are encapsulated in stainless steel housing.

Other configurations

Additional configurations for calibrated leak devices that may either have an undefined leak or can be used with other types of leak testers can also be provided. Thereby we also offer a broad range of test leaks with gas reservoir in connection with our tracer gas leak detectors. Please contact us directly for more information for those or other demands.

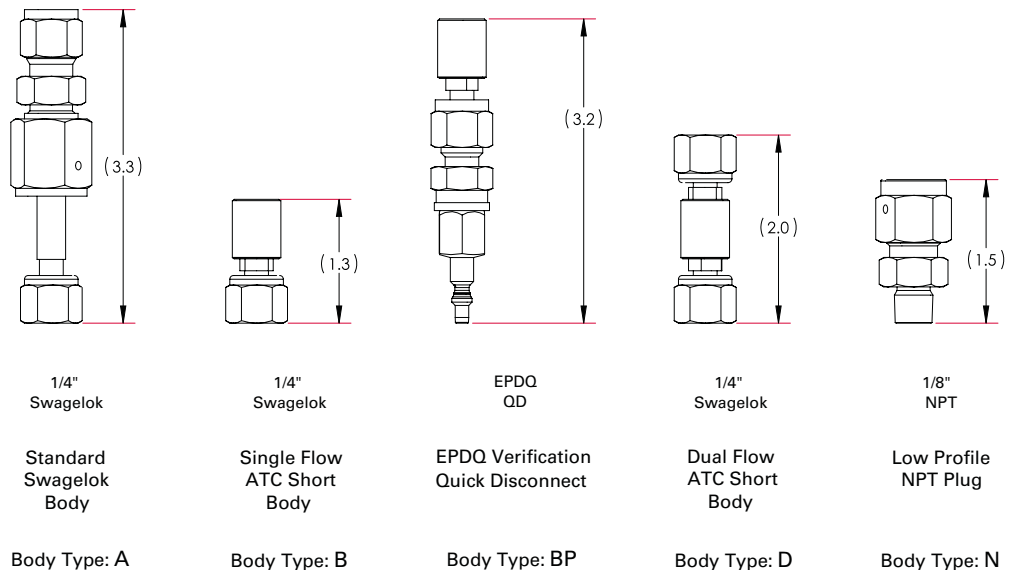

Technical data

Type	ECS	ECD	SE
Micro channel	L/D > 100	L/D > 100	L/D < 50
Available diameter	0.1, 2, 5, 10, 20, 25, 30, 40 μm (micro-meters, micron) Diameter roundness and tolerance is +/- 5% or +/- 0.53 micron, whichever is larger		
Length	From 1.25 mm to 5 mm length tolerance is +/- 0.25 mm		
	Each ECS is supplied with traceable gaging certificate of the inlet diameter, outlet diameter and minimum length.	Each ECD is certified for flow rate with air/nitrogen or other gasses per customer request (standard 3 points, air/nitrogen, barometric outlet, others available).	Each SE/ED is certified for flow rate with air/nitrogen or other gasses at the size built.
Leak flow rate (ECD only)		+/- 10% of nominal value	

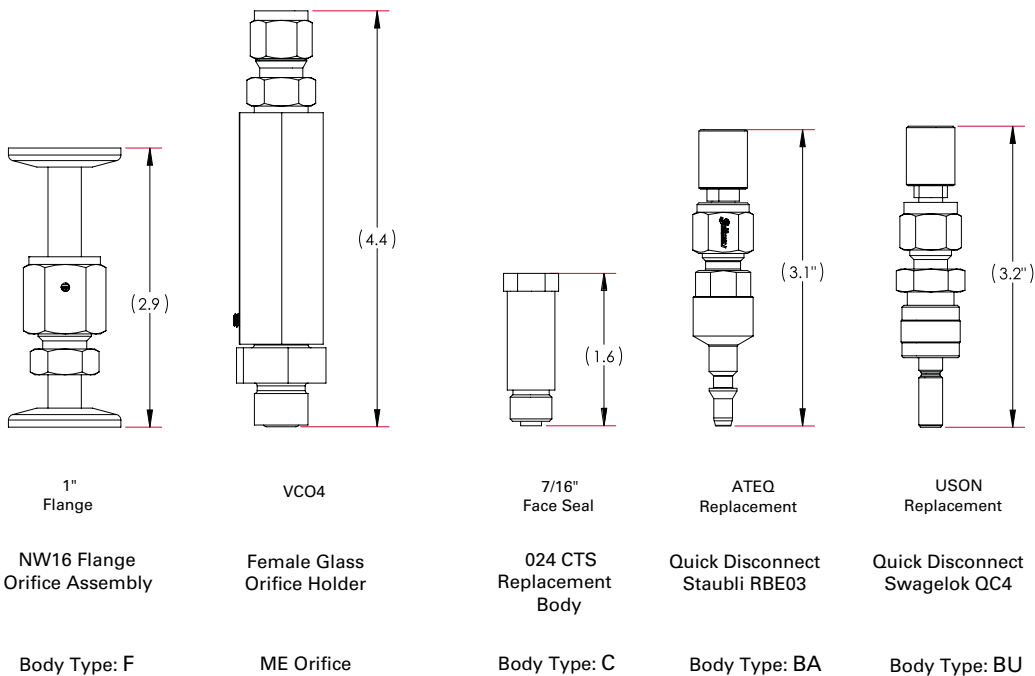

ACCESSORIES

Available options by model

Accessories

	E-PDQ ¹⁾	E2	VE2	IPE2	ME2	ME3
LeakTek™	■	■	■	■	■	■
Adaptive Test™ utility tools	■	■	■	■	■	■
Leak Rx™	■	■	■	■	■	■
Fine automatic pressure/flow controller		■	■	■		
Programmable automatic pressure controller for constriction/blockage tests with feedback sensor		■	■	■	■	
Expansion tank: small/medium	■	■	■	■	■	■
Expansion tank: large		■	■	■		
Precision pressure regulator: small/medium volume	■	■	■	■		
Precision pressure regulator: large volume, dual stage		■	■	■		
Verification orifice: ECD or ED	■	■	■	■	■	■
Verification orifice: ECS air calibration	■	■	■	■		
Glass orifice: calibrated at barometric inlet, vacuum outlet on primary std.	■	■	■	■	incl.	■
Remote exhaust valve with filter	■	■	■	incl.	incl.	incl.
Pre-fill option for large volume parts		■	■	incl.	incl.	incl.
Remote pressure sensor for external pressure monitoring		■	■	■	incl.	incl.
Large leak strain measurement for pouches			■		■	
Pressure drop option: large constrictions tests		■	■	■		
Oil-less vacuum generation and control package (ca. 0.3–0.8 bar abs.)	■		■		■	■
Oil-less vacuum generation and control package (ca. 0.07–0.15 bar abs.)	■		■		■	■
Oil-less vacuum generation and control package (ca. 0.07–0.15 bar abs.)			■		■	■
Shallow vacuum generation and control package	■		■		■	■
Remote pendant with Start/Stop button	■	■	■	■	■	■
A2LA certified calibration		■	■	■	■	■
Dual range calibration		■		■		
37 Pin shielded harness to PLC		■	■			
Mass Extraction UUT filter	■		■		■	■
Stainless steel enclosure for cleanroom applications		■		■	■	

¹⁾ Additional options available with the E-PDQ. See E-PDQ details.

Software

LeakTek™: A PC-based data acquisition program

Our software program provides a PC-based application which provides data collection and analysis, as well as test setup configurability. It communicates with our Micro-Flow test instruments via RS-232 or Ethernet connections. The Windows® XP Professional R operating system (or later) is required.

Features

Enables configuration, storage and retrieval of multiple test sequences and parameters.

- Test parameters are also stored in the test instrument's non-volatile memory for operation without an attached PC.
- User can specify mass or volumetric units, including flow at standard conditions.
- Gas type is selectable as well as limits for pressure and flow.
- Flow can be displayed based on volume or mass units per minute.
- Pressure can be displayed in various absolute or gauge units.
- Relative measurement allows you to auto zero the sensor just prior to stability and test modes (measurement).
- Reference measurement allows you to zero a master part, offsetting the entire curve of the test In reference to this master part or profile.

Leak-Rx™: FDA 21 CFR Part 11 compliant data acquisition

Leak-Rx is an FDA 21CFR Part 11 compliant version of the LeakTek software. Leak-Rx is setup with a protected database and temper proof data protection. Audit trail assures full change control and traceability. The program can only be used to configure sensors that are connected to the software with an encrypted key. Some of the program screens are shown on the right.

Adaptive test and set-up tools

Our patented adaptive test and set up tools enables the IGLS inside of the leak test instrument to learn parts signature and dynamically accepts or rejects the unit under test (UUT) based on statistical consideration. This feature reduces average cycle time by 25-40%.

Adaptive test performs the conventional leak test using one of our leak test instruments. Our leak test instruments make a direct measurement of the leak flow, not a derivative measurement as in pressure decay or helium mass spectrometry. This direct measurement allows detection of leaking parts with the ability to stop the test early for a UUT with a large leak rate.

Our leak test instruments adapt by learning the behavior of a group of parts, using statistical data to accept or reject a part in real time. By anticipating the part's behavior, the leak tester can determine the pass or fail status of the part before the test is completed or continues with the test if the part is marginal. This feature significantly reduces the average cycle time, allowing throughput to be significantly increased.

An RS-232 connection is used for communication using a USB to RS-232 cable. LeakTek has an optional RJ45 for Ethernet interface. Minimum PC requirement is Windows® XP Professional or later.

Note: The adaptive test should only be performed by trained users or ATC's application engineers. The benefits of adaptive test feature are application dependent.

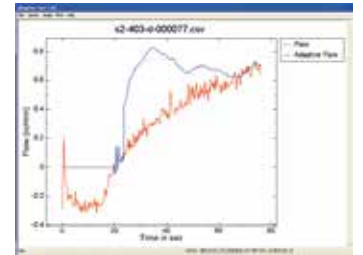
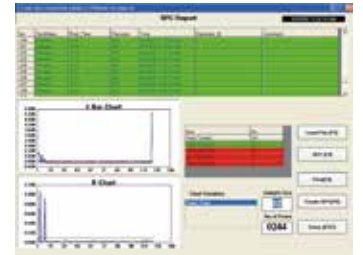
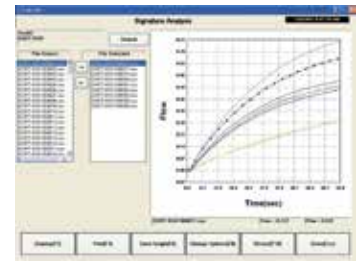

VACUUM SOLUTIONS FROM A SINGLE SOURCE

Pfeiffer Vacuum stands for innovative and custom vacuum solutions worldwide, technological perfection, competent advice and reliable service.

COMPLETE RANGE OF PRODUCTS

From a single component to complex systems:

We are the only supplier of vacuum technology that provides a complete product portfolio.

COMPETENCE IN THEORY AND PRACTICE

Benefit from our know-how and our portfolio of training opportunities!

We support you with your plant layout and provide first-class on-site service worldwide.

Are you looking for a
perfect leak testing solution?
Please contact us:

Pfeiffer Vacuum GmbH
Headquarters - Germany
T +49 6441 802-0

ATC LLC
4037 Guion Lane
Indianapolis, IN 46268 US
T +1 (317) 328-8492
atc@atcinc.net
www.atcinc.net

www.pfeiffer-vacuum.com

